

SPECIFICATIONS

Model		KX080-5		KX080-5 Angle Blade	
Type of cabin		ROPS / OPG (TOP Guard, Level I)			
Type of tracks		Rubber / Steel			
Engine	Model		Kubota V3307-CR-TE5		
	Output (SAE J1995 gross)	HP (kW)/rpm	66.6 (49.7) / 2000		
	Output (SAE J1349 net)	HP (kW)/rpm	62.3 (46.5) / 2000		
	Displacement	cu. in. (cc)	203.3 (3331)		
Dimensions	Overall length	ft. in. (mm)	21'1.9" (6450)		
	Overall height	ft. in. (mm)	8'4" (2540)		
	Overall width	ft. in. (mm)	7'2.6" (2200)		
	Min. ground clearance	in. (mm)	14.0 (355)		
Hydraulic system	Pump capacity	GPM (ℓ/min)	22.3 (84.6) Variable × 2		
	Auxiliary hydraulic flow	GPM (ℓ/min)	26.4 (100) / 14.7 (55.8)		
	Max. breakout force	Bucket / Arm	lbf. (kgf)	14660 (6650) / 8554 (3880)	
Drive system	Travel speed	Low / High	mph (km/h)	1.7 (2.7) / 3.0 (4.8)	
	Max. traction force	Low speed	lbf. (kgf)	15062 (6832)	
	Tumbler distance		ft. in. (mm)	7'6.6" (2300)	
	Crawler length		ft. in. (mm)	9'6.2" (2900)	
	Shoe width	Rubber / Steel	in. (mm)	17.7" (450) / 17.7" (450) (opt. 24" (610))	
	Ground contact pressure	Rubber / Steel	psi (kg/cm ²)	5.29 (0.372) / 5.35 (0.376)	5.56 (0.391) / 5.60 (0.394)
Swing system	Unit swing speed		rpm	9.8	
	Boom swing angle	Left / Right	degree	67 / 60	
Blade	Dimensions	Width	ft. in. (mm)	7'2.6" (2200)	
		Height	ft. in. (mm)	19.7" (500)	20.1" (510)
	Max. lift above ground		in. (mm)	19.7" (500)	
	Max. drop below ground		in. (mm)	19.7" (500)	
Angle		degree	— / 25		
Hydraulic oil (reservoir / system)			gal (ℓ)	19.8 (75) / 38.6 (146)	
Fuel reservoir			gal (ℓ)	30.4 (115)	
Operating weight (Including operator's weight @ 165 lbs.)		Rubber / Steel	lbs. (kg)	18520 (8400) / 18760 (8510) / 19470 (8830) / 19620 (8900)	

DIMENSIONS

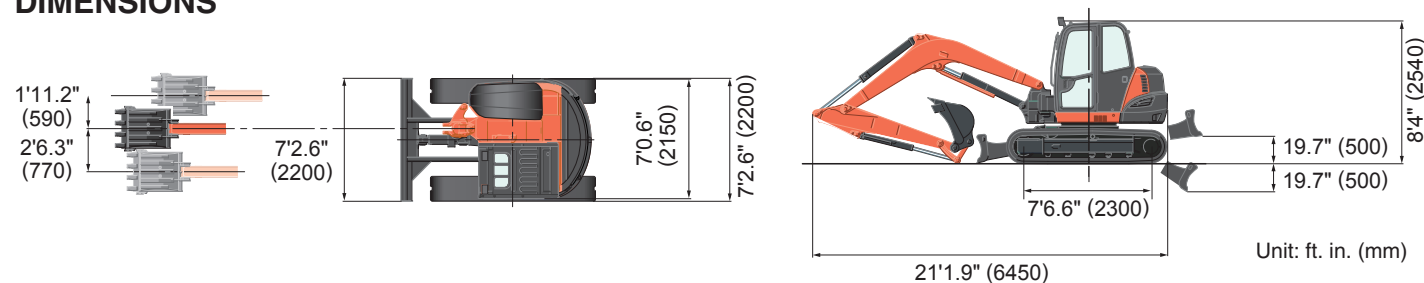

Kubota Tractor Corporation reserves the right to change the stated specifications without notice. This brochure is for descriptive purposes only and reasonable efforts were used to set forth the contained information; some items shown may be optional and some products shown may not be available at all dealerships. Kubota disclaims all representations and warranties, express or implied, or any liability from the use of this brochure. For complete warranty, safety and product information, consult your local Kubota dealer and the operator's manual. Power (HP/KW) and other specifications are based on various standards or recommended practices. For your safety, Kubota strongly recommends the use of a Rollover Protective Structure (ROPS) and seat belt in almost all applications. This brochure is intended for the United States and US territories only. For information regarding Kubota products or services outside these areas, see Kubota Corporation's global web site. Kubota does not provide parts, warranty or service for any Product which is re-sold or retailed in any country other than the country for which the Product(s) were designed or manufactured.



KUBOTA TRACTOR CORPORATION

1000 Kubota Drive, Grapevine, TX 76051 Tel 888-4 KUBOTA

Visit our web site at: www.kubotausa.com

©2023 Kubota Corporation



Kubota Genuine Parts
for excellent performance, durability and safety



For Earth, For Life

Kubota

KX

KUBOTA POWER UTILITY EXCAVATOR KX080-5

Powerful and easy to operate, the KX080-5 with the updated features makes it an excellent choice for your power utility excavation jobs.



AB
FLOAT ANGLE BLADE

A wide and roomy cab brings a new level of operating comfort to the job.

DELUXE INTERIOR

Spacious & Comfortable Cab

With new interior designs and new functions, the cabs offer improved comfort for operators of many sizes. The designs feature a slimmer, more ergonomically positioned right LCD screen and the quieter environment and much more foot space. That means improved productivity on the job.

Expanded Glass Area

A slimmer frame design enhances the spaciousness in the cab. That results in more visibility during loading, unloading, and digging work. Operators can monitor the left and right edges of the dozer in the front while grading as well as see the bucket through the skylight during unloading.



Low Noise 72dB*

A quieter cabin provides a more stress-free working environment. The low noise level protects the operator from engine noise and other loud sounds.

* Test conditions : Kubota in-house test result. During simple dirt excavation with door closed and heater at level 2. Actual results may vary.

Air Conditioner

Overall air circulation in the cab is better than ever, thanks to a stronger cooling/heating unit and the positioning of eight vents. Direct airflow to the operator together with the air circulation inside the cab provides excellent comfort.



A. Double Adjustable Air Suspension Seat

As part of the redesign, the cab is now equipped with a seat with a slide that can be double-adjusted to improve comfort. The joystick consoles on the left and right sides of the seat also can be adjusted independently of the seat to match individual operator requirements. Also, air suspension provides new comfort and height controlled by the air compressor.

B. Mobile Phone Holder / USB Charger

A convenient holder for your phone and a nearby USB charging port keep your phone within easy reach and fully charged.



C. Back-lighted Key Pad

Redesigned for greater comfort and improved operability, the key pad features a compact profile and places all of the main switches on the right side for easier access.



Superior power, advanced functionality, and a 2-pump system combine for excellent productivity and smoother operation.

WORKING PERFORMANCE

2-pump Load-Sensing Hydraulic System

2-pump load-sensing system improves the overall smoothness of operations when using front attachments, letting you effortlessly perform simultaneous operations. You'll notice the difference when simultaneously operating the front working group while traveling.

Kubota Engine

Common Rail System (CRS) and Diesel Particulate filter (DPF) Muffler

Kubota's engine is equipped with CRS and with efficient DPF which reduces maintenance by increasing the service intervals for both the regeneration filter and ash cleaner.

Automatic regeneration system

Automatic regeneration system automatically burns accumulated particulate matter (soot) in the DPF muffler, so the operator doesn't need to stop work to clean the DPF.

Auto-Shift

The auto-shift system enables automatic travel shift from high to low depending on traction effort and terrain. This gives smoother simultaneous operations when dozing and turning.

Tight Tail Swing and Compact Machine Width

Thanks to its contoured, tight tail design created by the shorter rear overhang, the KX080-5 has excellent stability, can handle a wider range of loads, and can work in more restrictive spaces. The compact 7'2.6" width of the undercarriage makes it ideal for working in close conditions, and much easier to transport between job sites.

7' 2.6" (2,200 mm)



Versatile Control

Two auxiliary circuits (AUX1 and AUX2) are available on the KX080-5. The maximum oil flow settings of both circuits are conveniently adjustable from the digital panel. No additional tools or complex manual adjusting procedures are necessary.

Auto Idling System

Reduce engine RPM instinctively when high engine speed isn't needed. When the control levers are in neutral for more than 4 seconds, the engine RPM automatically idles. Move any control lever and the engine RPM immediately returns.



Engine Auto Stop

The Engine Auto Stop system comes fitted as standard. The engine turns off automatically when it's been left idling too long. You can set the idling time to suit you.

Working Range

Kubota's updated 8 ton compact excavators deliver impressive performance and efficiency for their size, with exceptional bucket digging force, outstanding arm reach, reduced soil spillage when rotating and a well-matched arm and bucket. Even tough digging jobs will get done faster and more efficiently.

Hydraulic Angle Blade (option)



Save time and work more efficiently. With a simple movement of the new thumb operated rocker switch on the dozer lever, the hydraulic angle blade can be angled to the right or left to push soil to the side as the machine moves forward, eliminating the need for repetitive repositioning at right angles when backfilling trenches.

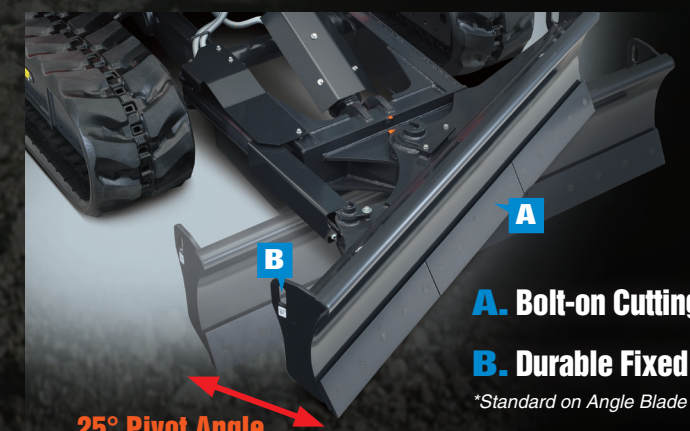

A. Bolt-on Cutting Edge*

B. Durable Fixed Hook

*Standard on Angle Blade models.

25° Pivot Angle

Float Position

You don't need to adjust the dozer height to make a clean ground surface—after backfilling, just travel backward along the covered ditch with the dozer in the float position. Ground finishing work is now fast and easy!



Advanced technology helps keep the operator and bystanders informed about the machine.

TECHNOLOGY

Keyless Start

Keyless start is available as standard for KX080-5. The engine can be started by entering a 4 digit passcode using the excavator key pad and up to 10 user passwords can be set. With this new function, customers do not have to worry about lost keys anymore.

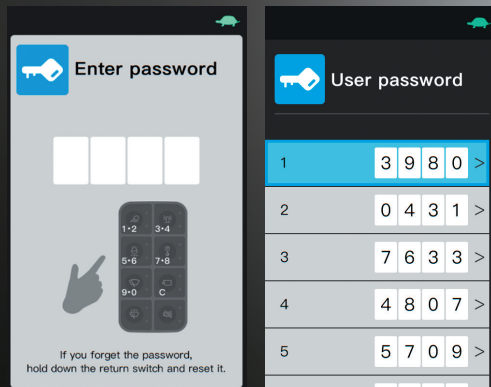

Telematics

The Kubota telematics solution connects your Kubota equipment to the tools you use. Get critical information like accumulated hours, fuel level, location, temperatures and more. KubotaNOW gives you the right information when and where you need it.

LED Work Lights with Turn-off Delay

The LED work lights can be programmed to turn off 30 seconds to 2 minutes after the engine has stopped. This allows the operator to exit the machine and walk away under full illumination.

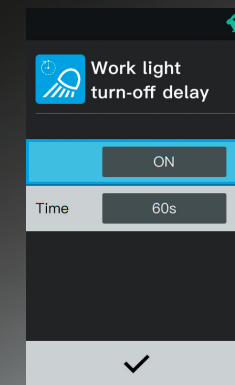

Rear-view Camera

Factory designed rear-view camera provides a fish-eye view to the rear of KX080-5 by displaying the view on the 7" LCD screen in the cab.

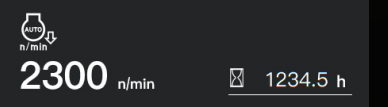
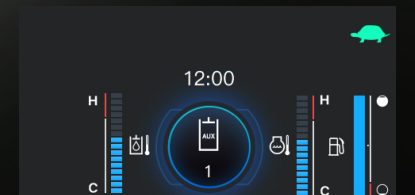

Automatic Activation of 3rd Line Hydraulic Return

No more climbing down from the cab and reaching under the bonnet to manually open and close the 3rd line hydraulic return. The KX080-5 features an electronically controlled 3rd line hydraulic return that is automatically activated when the operator selects one way flow mode on the digital panel in the cab.

Built for long-lasting dependability.

MAINTENANCE & SAFETY



One-sided Engine Maintenance

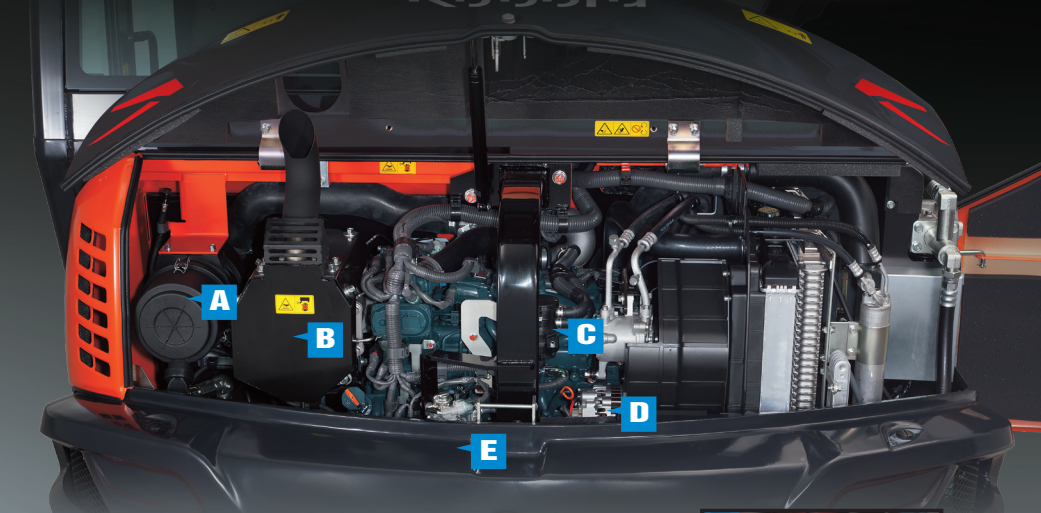

- A. Dual Element Air Cleaner
- B. DPF Muffler
- C. Fuel Filter
- D. Alternator
- E. Starter Motor



- F. Oil Filter
- G. Battery
- H. Water Separator
- I. Toolbox

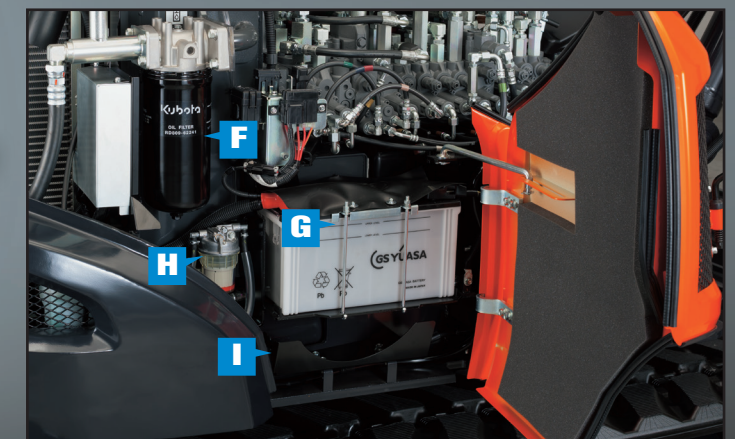

Triple Opening Hood

All three of the excavator's access panels can open at once. This allows you to easily inspect and view the centrally located components of the KX080-5. You can easily access the hydraulic components under the center hood, or the battery, oil filter and tool box under the right hood. Maintaining your excavator has never been this easy.

Two-Piece Hose Design

When an on-site replacement of a dozer cylinder supply hose is necessary, its two-piece design simplifies the job.

Intuitive operation and large LCD screen help to enhance performance.

DIGITAL PANEL



New Full-Color LCD Screen With Jog Dial

A full-color, high-resolution 7" LCD screen provides with a single glance all the information the operator needs to operate the compact excavator. An intuitive interface ensures quick understanding and easy access to the compact excavator's various functions, including AUX flow adjustment. Important maintenance items are also displayed, as are detailed alerts for improper machine functions and abnormalities. The new jog dial is both intuitive and easy to use. Even first-time operators will be able to quickly access all important information. Keyless start system is available for the operator's convenience.

Menu icons

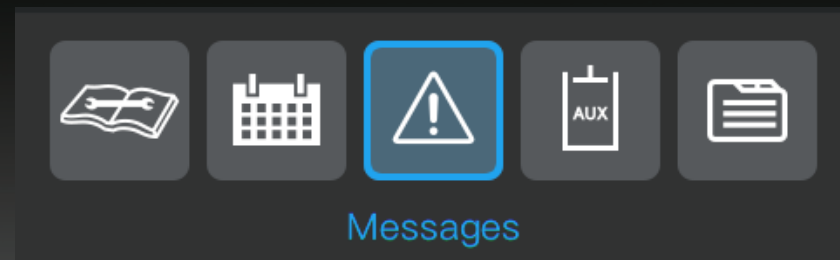

- A. Alert Indicator
- B. Hydraulic Temperature
- C. AUX Mode
- D. Water Temperature
- E. Fuel Level

Standard Monitor Display

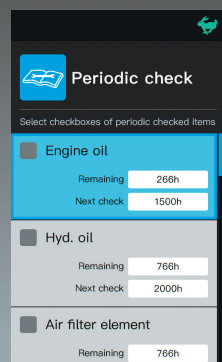

Periodic Check

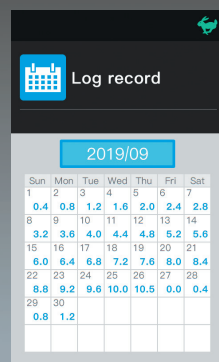

Log Record

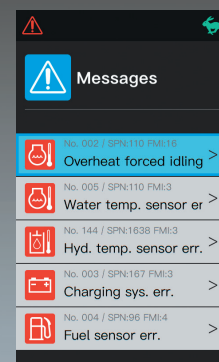

Message Mode

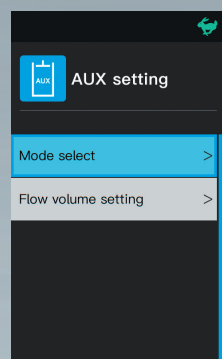

AUX Setting

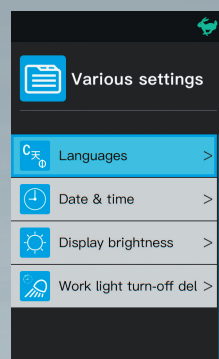

Various Setting

- A. Menu Key
- B. Return Key
- C. Jog Dial
- D. Working Light
- E. Beacon Light (Opt.)
- F. Auto Idle
- G. Wiper
- H. Rear-view Camera
- I. Washer Fluid
- J. Travel Alarm Off (Opt.)



KX080-5 OPTIONS

STANDARD EQUIPMENT

Safety system

- Engine start safety system
- Travel motor with disc brake
- Swivel motor with disc brake
- All hydraulic control

Working equipment

- Auxiliary hydraulic circuit 1 and 2 (proportional control)
- 3 LED working lights on cab and 1 LED light on the boom
- LED working lights with turn-off delay
- Thumb bracket and relief valve
- Rear view camera

Operator's space

- Cab with A/C
- Retractable seat belt
- Hydraulic pilot control levers with wrist rests
- Travel levers with foot pedals
- Two pattern selection system
- 12V power source
- Cup holder
- Mobile phone holder
- USB charger

- Horn
- 2-speed travel switch on dozer lever
- ROPS/OPG (TOP, Guard, Level 1)
- Double adjustable air suspension seat
- 7" full color LCD screen with jog dial
- Keyless start

Engine/Fuel system

- Double element air filter
- Auto idling system
- Water separator
- Engine auto stop

Undercarriage

- Dozer blade with float function
- 17.7" (450mm) rubber track
- 1 x upper track roller
- 5 lower track rollers on each side
- 2-speed travel with auto-shift

Hydraulic system

- Pressure accumulator
- Hydraulic pressure checking ports
- Automatic activation of third line hydraulic return
- 2-pump load sensing system
- Adjustable maximum oil flow on auxiliary hydraulic circuits 1 and 2

Others

- Telematics
- Tool box
- Grease gun holder

OPTIONAL EQUIPMENT

- Beacon lights
- 17.7" (450mm) and 24" (610mm) steel track
- Angle blade with float function and BOE
- Travel alarm
- Window Guard

Stay connected with KubotaNOW

KubotaNOW telematics gives you the right information, when and where you need it. To access KubotaNOW telematics information, download the myKubota app and stay connected to your Kubota machine. Get information like hours, fuel level, location, temperatures, error codes, and more.



WORKING RANGE

Model		KX080-5		
A	Max. digging height	ft. in. (mm)	23'11.4" (7300)	
B	Max. dumping height	ft. in. (mm)	17'2.7" (5250)	
C	Max. digging depth	ft. in. (mm)	15'1.1" (4600)	
D	Max. vertical digging depth	ft. in. (mm)	12'7.6" (3850)	
E	Max. digging radius at ground	ft. in. (mm)	23'6.3" (7170)	
F	Max. digging radius	ft. in. (mm)	24'0.6" (7330)	
G	Min. turning radius	W/O swing	ft. in. (mm)	8'2.0" (2490)
		W swing	ft. in. (mm)	6'8.7" (2050)
H	Min. tail turning radius	ft. in. (mm)	4'9.5" (1460)	

LIFTING CAPACITY

LIFT POINT HEIGHT (ft)	LIFTING CAPACITY OVER-FRONT BLADE DOWN unit=1000 lbs				LIFTING CAPACITY OVER-SIDE unit=1000 lbs		
	LIFT POINT RADIUS (ft)				LIFT POINT RADIUS (ft)		
	12	18	MAX.	12	18	MAX.	
GL	12	3.6	3.4	3.4	3.6	2.1	1.9
	8	5.0	3.7	3.4	3.9	2.1	1.7
	4	6.5	4.0	3.5	3.5	2.0	1.6
	0	7.2	4.2	3.6	3.3	1.9	1.6

Machine with cabin and rubber crawler, without bucket

